

# FUMEX ME 50



**The ideal extractor for schools, nail salons and the electronics industry.**

With its optimal design, the  $\varnothing$  50 mm Fumex ME has a very low pressure drop, which provides many valuable benefits:

- Low pressure drop saves energy.
- Air flow noise is reduced.
- Lower pressure drop is achieved without selecting a larger diameter extractor.
- Lower pressure drop allows the ME to be combined with additional extraction systems.

Unique design and stable mounting brackets make the Fumex ME your best choice.

Support for designing an effective system is available on page 5, and at [www.fumex.com](http://www.fumex.com) where you will find our design tool and CAD drawings.

*The Fumex range also includes fans, accessories, automatic controls and filters suitable for local extraction.*

**LOCAL EXTRACTION**  
**Pure advantages**

# FUMEX ME 50

## Always choose a low pressure drop

Lowest possible pressure drop is a quality aspect that always should be considered.

With its uniquely designed joint construction, Fumex ME combines maximum flexibility with low pressure drop. The air passes through the joints without creating unnecessary turbulence, thus producing an energy-saving low pressure drop and a quieter working environment.



## Recommended air flow

The recommended air flow for a  $\varnothing 50$  arm is 55-75 m<sup>3</sup>/h, See table and diagram.

Activity	Air flow	
Laboratories	50-75 m <sup>3</sup> /h	15-21 l/s
Schools	50-75 m <sup>3</sup> /h	15-21 l/s
Nail salons	65 m <sup>3</sup> /h	18 l/s

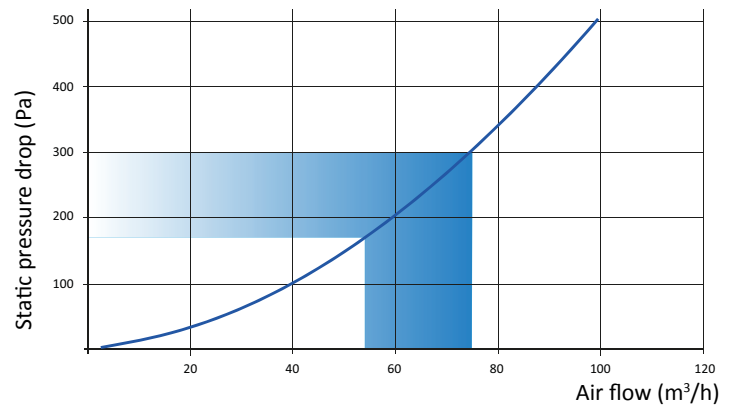

## Optimal capture

For optimum benefit from the local extractor, it is important to use the flexibility of the extractor to get as close to the contaminant as possible. A good rule of thumb would be a distance of 2-3 times the diameter of the extractor tube. At the recommended air flow, the extractor will provide high efficiency even if disturbances are generated in the surroundings.

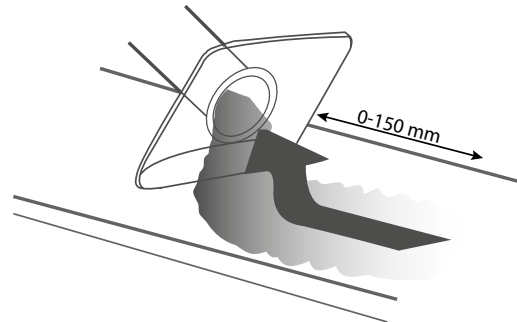

## Unique benefits

The Fumex ME joints have a patented friction design that, combined with the large joint diameter and single grip handle, provide a secure, position-stable arm with smooth adjustments. All without the need to apply excessive force or use tools on the adjusting knob.

Joints with reinforced ends and ball bearings moderate the friction and allow the arm to be moved up and down while maintaining stability and function.

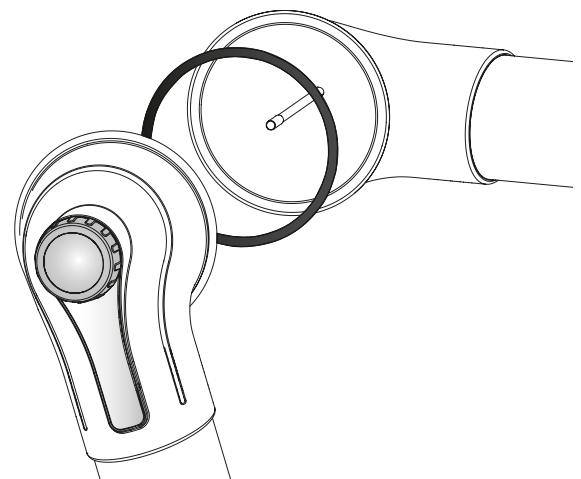

# FUMEX ME 50

---

## *One arm. All options.*

Fumex ME has a complete range of accessories to suit every situation, enabling you to create the optimal extractor for the evacuation of hazardous airborne gases and particulates.



### **Standard version**

Suitable for evacuating most types of airborne contaminants, e.g. in laboratories, schools, hospitals, the pharmaceutical industry, nail salons and light industrial applications.



### **ESD version**



Suitable for evacuating airborne contaminants in environments where there is a need to avoid the risk of spark formation and in areas where products need to be ESD-certified, e.g. the electronics industry.



# FUMEX ME 50

## MET for ceiling and wall mounting, 3 joints

Standard	Size (mm)			Weight (kg)
	A	B	∅ C	
MET 1000-50	400	300	50	1,50
MET 1300-50	550	450	50	1,65
MET 1500-50	750	450	50	1,70

ESD	Size (mm)			Weight (kg)
	A	B	∅ C	
MET 1000-50ES	400	300	50	1,50
MET 1300-50ES	550	450	50	1,65
MET 1500-50ES	750	450	50	1,70

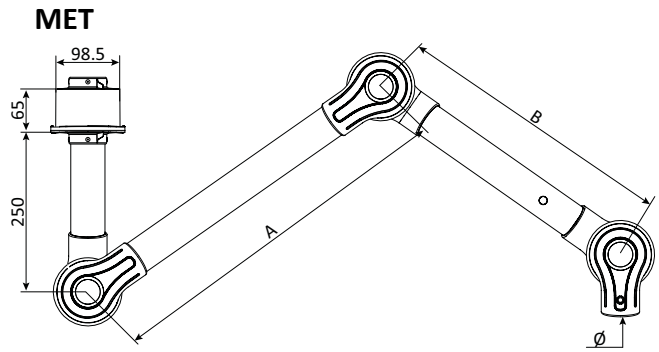

MET for ceiling or wall mounting, excluding bracket MTI or MVK.

## MEB for table mounting, 3 joints

Standard	Size (mm)			Weight (kg)
	A	B	∅ C	
MEB 1000-50	400	300	50	1,50
MEB 1300-50	550	450	50	1,65
MEB 1500-50	750	450	50	1,70

ESD	Size (mm)			Weight (kg)
	A	B	∅ C	
MEB 1000-50ES	400	300	50	1,50
MEB 1300-50ES	550	450	50	1,65
MEB 1500-50ES	750	450	50	1,70

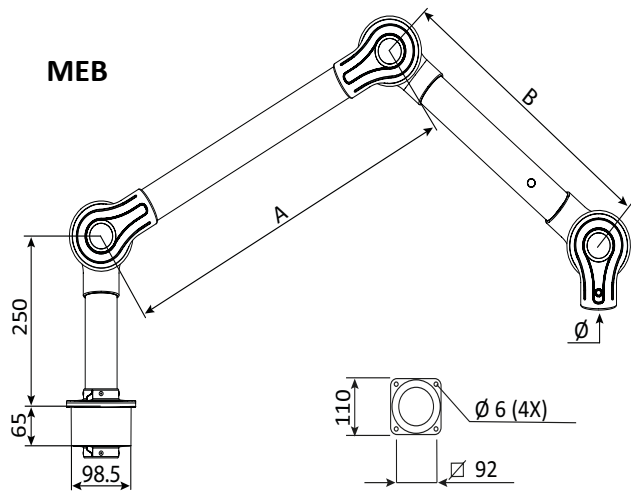

## MET for ceiling and wall mounting, 2 joints

Standard	Size (mm)		Weight (kg)
	A	∅ C	
MET 650-50	300	50	1,00
MET 750-50	450	50	1,10

ESD	Size (mm)		Weight (kg)
	A	∅ C	
MET 650-50ES	300	50	1,00
MET 750-50ES	450	50	1,10

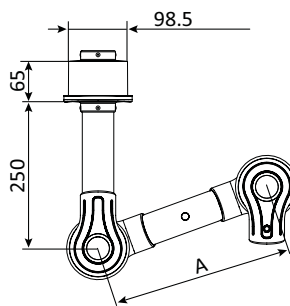

MET for ceiling or wall mounting, excluding bracket MTI or MVK.

## MEB for table mounting, 2 joints

Standard	Size (mm)		Weight (kg)
	A	∅ C	
MEB 650-50	300	50	1,00
MEB 750-50	450	50	1,10

ESD	Size (mm)		Weight (kg)
	A	∅ C	
MEB 650-50ES	300	50	1,00
MEB 750-50ES	450	50	1,10

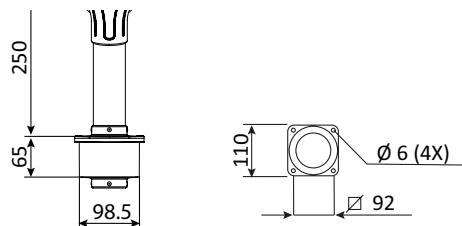

# FUMEX ME 50

## MEBC for table mounting, 1 joint.

ESD	Weight (kg)
MEBC 700-50ES	0,8

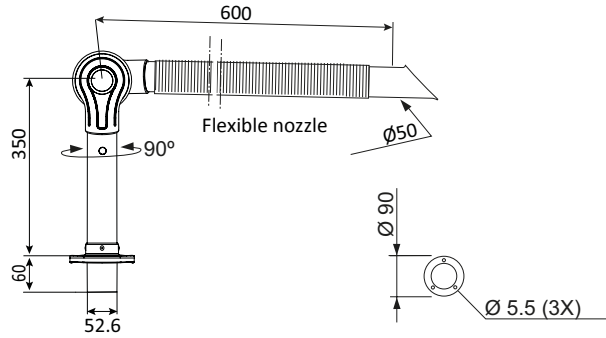

## Reach at recommended installation height

The following installation heights and sideways displacement relative to the work area are recommended for optimal extraction:

### Recommended installation height

Designation	H (mm)
MET 1000-50	1700-2000
MET 1300-50	1900-2200
MET 1500-50	2000-2300

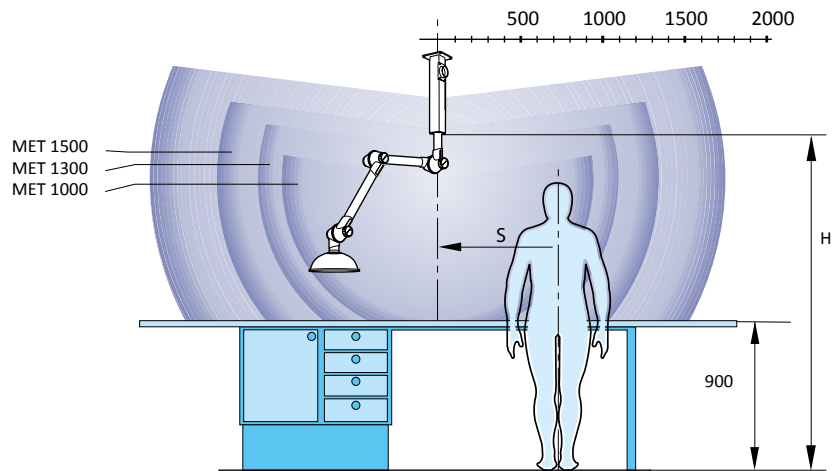

### Recommended side displacement

radius, relative to work area

Designation	S (mm)
MET 1000-50	300-600
MET 1300-50	400-700
MET 1500-50	500-800

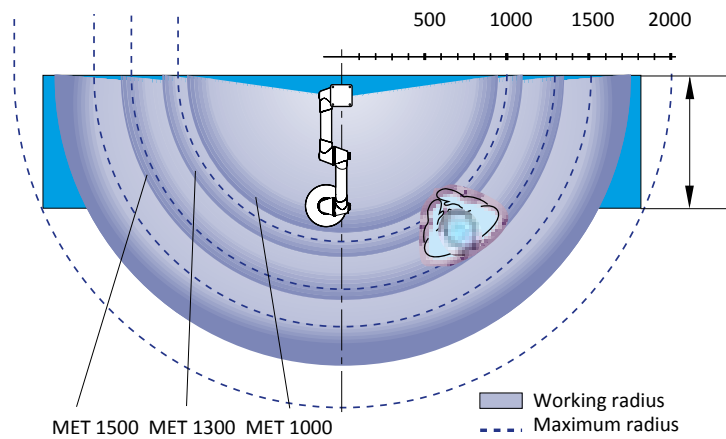

## Pressure drop

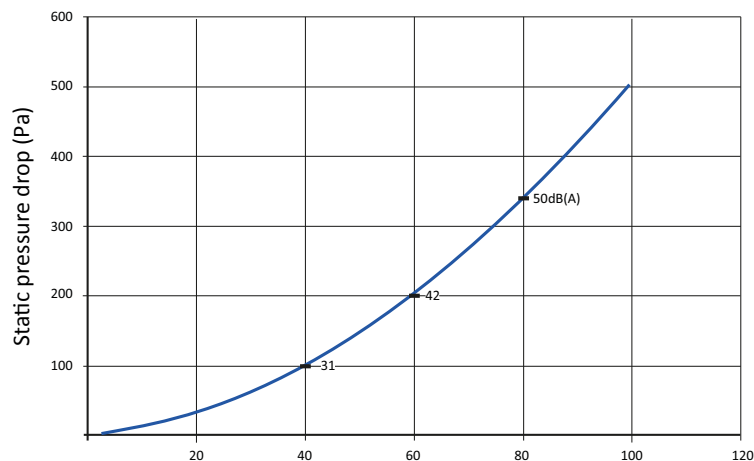

Static pressure drop is measured in accordance with ISO standard 5167-1. Air flow (m<sup>3</sup>/h)  
 Noise level is measured in accordance with ISO standard 3743.  
 Indicated sound level refers to sound pressure level.

# FUMEX ME 50

## Hoods

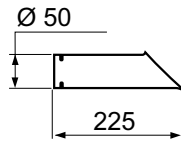

### SUCTION NOZZLE

The suction nozzle is used in tight spaces and for getting close to the work without interfering.

Temp. range: -15°C to +80°C

Standard	Variants	Vikt (g)
MES 300-50	ES	115

Material  
Standard: Aluminium  
ES PEEL black

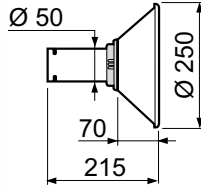

### METAL HOOD

The metal hood is used when working in corrosive environments and for capturing hot gasses and dust splatter.

Metal hoods can be fitted with work lighting.

Temp. range: -15°C to +80°C

Standard	Variants	Vikt (g)
MEM 250-50	ES	300

Material  
Standard: Powder-coated aluminium  
ES Aluminium

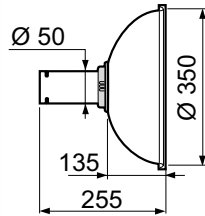

### DOME HOOD

The clear dome hood is suitable for lighter gasses with a wider dispersal of contaminants without blocking the user's vision.

Temp. range: -15°C to +80°C

Standard	Variants	Vikt (g)
MEK 350-50	ES	415

Material  
Standard: PMMA  
ES PEEL black

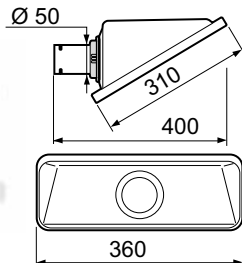

### SQUARE HOOD

The square hood is suitable for placing above gasses with a high lift, or adjacent to the work surface for contaminants with no lift or low lift – all this without interfering with the work.

Temp. range: -15°C to +80°C

Standard	Variants	Vikt (g)
MESH 350-50		450

Material  
Standard: PETG

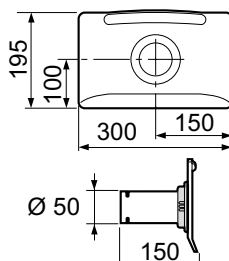

### FLAT SCREEN HOOD

The flat screen hood is designed to maximise the working area without obscuring the object from the user. The flat screen hood gives the best suction effect for table and bench tasks.

Temp. range: -15°C to +80°C

Standard	Variants	Vikt (g)
MEPH 300-50	ES	330

Material  
Standard: PETG  
ES PEEL black

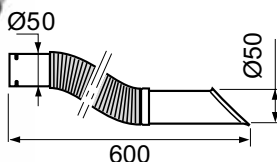

### FLEXIBLE SUCTION NOZZLE

The flexible suction nozzle is designed to maximise ease of movement without sacrificing air flow efficiency. Available in the ESD version only.

Temp. range: -15°C to +80°C

Standard	Variants	Vikt (g)
MEFS 600-50ES	-	315

# FUMEX ME 50

## Brackets



All Fumex laboratory extractors have as standard a full swivel that allows 360° of rotation without the need to add special sleeve couplings.

Both ceiling and wall brackets have a special square-shaped profile in anodised aluminium to provide a stylish and stable installation. This aluminium profile also allows both the wall and ceiling brackets to be custom tailored at the job site.

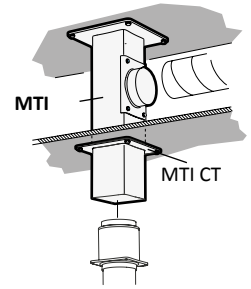

### The MTI and MTF ceiling bracket

The ceiling bracket functions as a simple and stable duct for outgoing air, avoiding the need for expensive ducting and additional holes through false ceilings. On request, the MTI can be supplied in lengths exceeding 2 m.

Standard	Dimensions (mm)		Weight (kg)
	L		
MTI 250	250		3,15
MTI 500	500		3,80
MTI 750	750		4,50
MTI 1000	1000		5,15
MTI 1250	1250		5,80
MTI 1500	1500		6,45
MTI 1750	1750		7,10
MTI 2000	2000		7,75

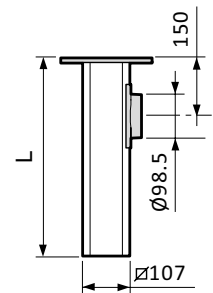
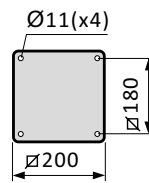
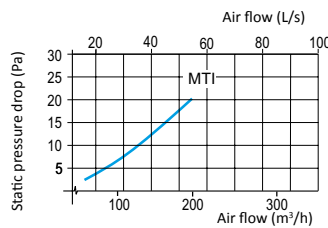

Ceiling bracket, for fitting through beams. The attachment plate is adjustable for the entire length of the aluminium profile. If required, the aluminium profile can be cut during fitting.

Standard	Dimensions (mm)		Weight (kg)
	L		
MTF	1000		4,20

As well as the standard design, the MTI and MTF are available in ESD (ES) versions.

The ceiling brackets can be supplied with an epoxy-coated exterior in all lengths up to 3 m (L).

For aggressive environments, we recommend epoxy coating on the interior and exterior up to 1.25 m (IL).

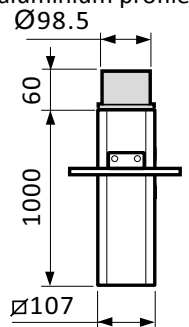
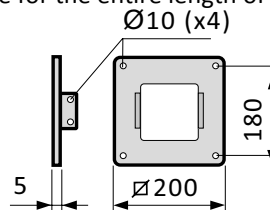

### The MTI CT escutcheon plate

Escutcheon plate, used with the MTI ceiling bracket for stabilization and to cover ducting in false ceilings.

Standard	Weight (kg)
MTI CT	0,050

As well as the standard design, the escutcheon plate is available in an ESD (ES) version.

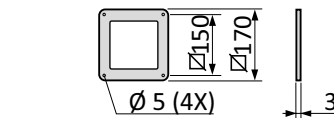

### MVK wall bracket

Included as standard for a wall-mounted arm.

Wall brackets can be special ordered in custom horizontal and vertical lengths.

Standard	Weight (kg)
MVK	2,15

As well as the standard design, the bracket is available in an ESD (ES) version.

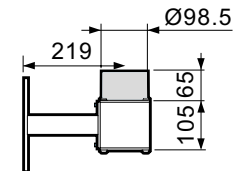
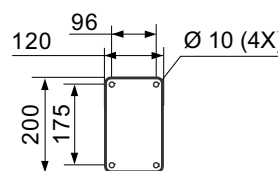

### MBF flexible table bracket

Flexible bracket for attaching to a table-top or shelving. Supplied complete with two clamps.

Standard	Weight (kg)
MBF	0,75
MBFC ES	0,70

As well as the standard design, the table bracket is available in an ESD (ES) version.

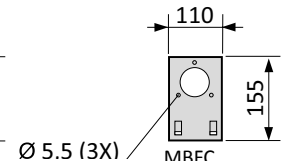
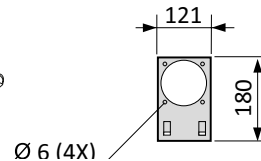
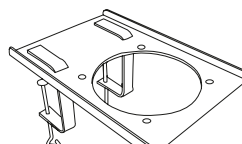

### MRM reducing sleeve

Polypropylene, fits standard Ø 98.5 mm attachment, for reducing down to Ø 50

Standard	Weight (kg)
MRM 100-50	0,08

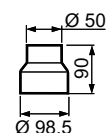





## Material description

### Friction joints

Ball bearing-equipped adjustable friction joints in polypropylene (PP), with guide ring in low friction-treated rubber. Support springs and other component parts in zinc-plated steel or stainless steel.

### Tubes

Made from thin-walled anodised aluminium. Air-tight damper supplied as standard.

### ME Standard

The standard ME version has polypropylene joints and anodised aluminium tubes.

The standard ME version is suitable for evacuating most types of airborne contaminants, e.g. in laboratories, schools, hospitals, the pharmaceutical industry, hairdressing salons and light industrial applications.

### ME ESD



Joints are made from conductive polypropylene, making the entire arm electrically conductive and diverting any static electricity to a separate earth connection.

The ESD version of the ME is suitable for the evacuation of airborne contaminants in environments where there is a need to avoid the risk of spark formation caused by static electricity and in areas where products need to be ESD-certified for use, e.g. the electronics industry. The ME ESD has been approved in accordance with EN 61340-5-1.

## Delivery

**Ceiling-MET** Supplied assembled, excluding hood or suction nozzle. The MTI or MTF ceiling brackets should be ordered separately.

**Wall-MET** Supplied assembled, excluding hood or suction nozzle. MVK wall bracket should be ordered separately.

**Table-MEB** Supplied assembled, with attachment plate for table fitting, excluding hood or suction nozzle. The MBF flexible table bracket should be ordered separately.

# FUMEX

Verkstadsvagen 2, 931 61 Skelleftea, Sweden  
Tel : +46 910-361 80, Fax: +46 910-130 22  
[www.fumex.com](http://www.fumex.com) [info@fumex.se](mailto:info@fumex.se)